

# SMSB131BW

*Instruction manual English V1.1*

## Let's switch it!



---

### **ELBROBUTLER - switch, control and monitor your system!**

- Remote switching: Switching devices on or off throughout the world
  - Remote control: Monitoring of devices and systems
  - Alerting: Simultaneously to different persons via SMS or email
  - Remote access: All-time access to the switching state, temperature and air humidity via SMS
  - Activation: Very easy, thanks to the intuitive App for Android and iOS
-

**1 Table of contents**

**2 Warning notice concept** ..... 3

**3 Qualified personnel** ..... 3

**4 Disclaimer** ..... 3

**5 Email service (This function is currently not available)** ..... 3

**6 Comments** ..... 3

**7 Warranty** ..... 3

**8 Returns** ..... 4

**9 Installation** ..... 4

    9.1 Safety instructions ..... 4

    9.2 Ambient conditions ..... 4

    9.3 Supply ..... 4

    9.4 Digital and analog inputs ..... 5

    9.5 Relay output ..... 5

**10 SIM card** ..... 5

**11 Overview of article set contents** ..... 6

**12 Accessories** ..... 7

**13 Dimensions** ..... 8

**14 Interfaces** ..... 9

**15 Installation diagram** ..... 10

    15.1 Analog input ..... 10

    15.2 Digital inputs ..... 10

    15.3 Relay output ..... 10

**16 Programming** ..... 11

    16.1 Getting started ..... 11

    16.2 Registration ..... 11

    16.3 Settings ..... 11

    16.4 Coupling the device via bluetooth ..... 12

    16.5 System status ..... 12

    16.6 System settings ..... 13

    16.7 Alarms and functions ..... 14

    16.8 Periodic status message ..... 14

    16.9 Wi-Fi settings ..... 15

    16.10 Wireless accessories ..... 15

    16.11 Save ..... 16

    16.12 System ..... 16

**17 SMS commands** ..... 17

    17.1.1 Switching relays on/off ..... 17

    17.1.2 Status request ..... 17

    17.1.3 Thermostat function ..... 17

**18 Manual switch** ..... 17

    18.1.1 Switching the relay in manual mode ..... 17

    18.1.2 Manual restart ..... 17

    18.1.3 Manual restart to default setting ..... 17

**19 Technical data** ..... 18

---

## 2 Warning notice concept

---

This manual contains instructions which you must observe for the purpose of your personal safety as well as for the prevention of material damage. Instructions with regard to your personal safety are indicated by a hazard triangle, instructions exclusively concerning material damage are shown without a hazard triangle. Depending on the hazard level, the warning information is represented in descending order as follows.

**DANGER**

Means that non-compliance with the corresponding precautionary measures may result in death or severe physical injury.

**WARNING**

Means that non-compliance with the corresponding precautionary measures may result in death or severe physical injury.

If several hazard levels apply, the warning notice for the highest level is always used. If the information of a warning notice warns against personal injuries with the hazard triangle, the same warning notice may include an additional warning against material damage.

---

## 3 Qualified personnel

---

The product/system which this documentation applies to must only be handled by personnel qualified for the respective task, taking the corresponding documentation for the task in question into account, in particular the safety and warning instructions included. On the basis of their professional training and experience, qualified personnel shall be fit for detecting risks when handling these products/systems and for avoiding potential hazards.

---

## 4 Disclaimer

---

ELBRO AG reserves the right to alter the technical data of the products and/or discontinue their production and provide new functions or new instructions for products already sold without the need for any notice and without any obligation. ELBRO AG can neither be held responsible for losses nor for direct or indirect damage resulting from the use of the products. The product is not suitable for the use or application for parts of vital assistive devices/systems or for applications which, if the product is not working properly, may cause material damage and/or personal injuries or may pose a danger to life or impair the physical integrity of persons, animals and living beings. Furthermore, the product must neither be installed for military applications nor for applications in which incorrect functioning or malfunction may cause flooding and/or fires. The device may only be operated under the climatic conditions specified in the instruction manual and maintenance book.

The customer shall undertake to check the product for compatibility with the guidelines for its final installation. The user is aware of the fact that he/she shall bear the full and sole responsibility for the optional remote control function. The use of the product is not suitable for other purposes such as the activation of external devices and/or devices with fraudulent functions or for unlawful purposes.

ELBRO AG assumes no liability for the incorrect functioning of the device due to potential faults, missing signals, interruption of the LTE/UMTS/GSM/GPRS network or external reasons such as improper installation or maintenance. On no account, ELBRO AG shall be responsible for the costs additionally charged by the mobile network operator for the repeated transmission of SMS or repeated GPRS data connection by the device. Despite diligent preparation of this manual by ELBRO AG, errors or omission cannot be entirely ruled out. ELBRO AG reserves the right to alter sections of this manual in the event of errors or changes to the product characteristics without giving any further notice.

---

## 5 Email service (This function is currently not available)

---

ELBRO AG neither guarantees the successful dispatch of emails nor interruption-free operation of the email service. ELBRO AG reserves the right to discontinue the service without giving further notice. The use of LTE/GPRS/UMTS data can cause high connection costs. We therefore recommend contacting your telephone provider to find the subscription suited best. In no case, ELBRO AG or its suppliers shall be liable for lost sales or lost profits, or for indirect consequential or incidental damage, whether for reasons (including negligence) arising from or in connection with the use or the impossibility of use of the product, even if the possibility of such damage has been pointed out to ELBRO AG. ELBRO AG, its subsidiaries, affiliated companies or group companies, or the distributors and resellers of ELBRO AG do not guarantee that the functions will reliably meet your expectations and that the corresponding firmware and software are free from defects or work continuously.

---

## 6 Comments

---

All information included in this document can be changed without any advance notice. Duplication of this manual is permitted to the user for personal purposes only, irrespective of the technique used in each case and the means applied for this purpose both electronically and materially, including photocopies or storage and is prohibited in all other cases without a special written approval. The utilisation, copying, modification, disassembly or transmission of the software are only permitted for the purposes expressly approved by this license and are otherwise prohibited. All other brands or products mentioned refer to the owner in question.

---

## 7 Warranty

---

All ELBRO products are subject to a strict quality control. If an ELBRO Butler should not work perfectly nevertheless, we regret this very much and kindly ask you to contact your dealer.

- The warranty is 2 years starting from the purchase date. During this period, the warranty will be limited to defects that can be verifiably traced back to material, execution or design flaws on the part of ELBRO AG.

- The warranty will be exclusively limited to the products delivered by ELBRO. Any further warranty or compensation shall be ruled out. In particular, costs relating to transport, disassembly, assembly, or costs due to consequential losses shall not be borne.
- In the case of non-authorised changes or repairs, or if the assembly or operating instructions have not been complied with, the warranty claim shall be void.
- A warranty service requires that the defective product is delivered in packaged condition, with carriage paid to ELBRO AG.

---

## 8 Returns

For commercial returns, our defined principles in accordance with our terms of business (AGB) shall apply. Please consult our website to view our detailed return policy. Repairs on the device must only be performed by ELBRO. Return defective devices to your dealer. Returns and repairs to ELBRO will only be taken into consideration if a comprehensive report on the error description and a receipt proving the purchase of the device within the warranty period are provided to us. We reserve the right to return devices without a comprehensive report and proof of purchase without comment and to invoice the return consignment. Package the device for a return shipment, if possible using the original packaging, so that it can be transported safely.

---

## 9 Installation

For reasons of safety for the user and to ensure flawless operation of the SMSB131BW, the device must only be installed by qualified personnel. Furthermore, the provisions listed in the following must be complied with.

---

### 9.1 Safety instructions

- The SMSB131BW is provided with a low-power radio transceiver. During operation, it transmits and receives high-frequency energy. Operation near radios, TVs, telephones or electronic devices in general can cause faults. The SMSB131BW can also be exposed to faults that impair its performance.
- Do not install the SMSB131BW near cardiac pacemakers, hearing aids or medical devices in general, since this may affect the proper operation of these devices.
- The SMSB131BW must not be installed on board of aeroplanes.
- Do not install the SMSB131BW in places where flammable gases or vapours may occur.
- The SMSB131BW works with a radio signal; no mobile operator can guarantee 100 % availability of a connection. Therefore, the SMSB131BW must not be used in life support systems.

---

### 9.2 Ambient conditions

The SMSB131BW (the device and all cables connected to it) is to be installed in places that meet the following conditions:

- No dust, no humidity, no high temperatures
- No direct sunlight
- No devices emitting heat
- No objects that generate a strong electromagnetic field
- No corrosive liquids or chemical substances
- The SMSB131BW has been designed for operation at an ambient temperature between - 40 °C and + 80 °C (operating temperature without load).
- Sudden temperature and/or humidity changes are to be avoided.

---

### 9.3 Supply

The following provisions must be complied with:

- Do not use any cables with a length of more than 2.9 m
- The external power supply unit must be a switching power supply certified in compliance with class 2 (LPS).
- Observe the correct polarity of the power supply cables

## 9.4 Digital and analog inputs

The following provisions must be complied with:

- Only potential-free contacts may be connected. If analog sensors are connected, they have to be suited and certified for this purpose.
- Do not use any cables with a length of more than 2.9 m
- Do not connect analog inputs to voltage sources
- Do not install cables near electromagnetic fields, otherwise use shielded cables
- Observe the correct polarity for analog inputs

## 9.5 Relay output



- Observe the technical data in the corresponding chapter
- Do not use any cables with a length of more than 2.9 m
- Use the same voltage level for all relays: In the case of high voltage switching circuits, only the phase conductor may be switched via the relay contact.

## 10 SIM card

### 10.1.1 Activation

First get a SIM card from any network provider. The user must activate the caller ID of the SIM card. We recommend **deactivating the PIN code of the SIM card in advance**. If necessary, please refer to your network provider for assistance. Keep the SIM card number and the password secret. Only share this information with the authorised users, in order to ensure security. We also recommend deactivating the answering machine and all additional functions such as advertising SMS by the telephone operator. Furthermore, make sure that your SIM card is always provided with sufficient credit and check the correct activation by sending SMS test messages.

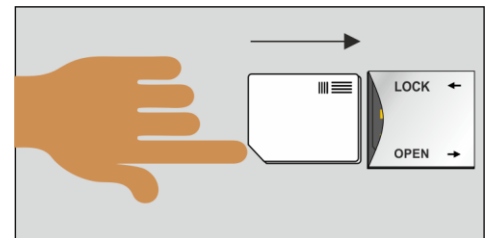

The SMSB131BW works with commercially available SIM cards allowing for the transmission and reception of SMS. With mere data SIM cards, the Butler cannot be utilised to its full extent. In case of doubt, please refer to your network provider. If you decide on using a prepaid SIM card, the SMSB131BW is provided with a credit query function: We recommend activating this function, so as to ensure that you always are in control of your remaining credit.



### 10.1.2 Insertion

Please unlock the SIM slot before inserting the SIM card and open the cover. Afterwards place the SIM card into the SIM slot with the **gold contacts pointing downwards** (see illustration). Close and lock the cover.

## 11 Overview of article set contents

Model	SMSB131BW	SMSB131BW-K1	SMSB131BW-K2
E-No.	539 109 500	539 109 510	539 109 520
EAN No.	7611664188893	7611664189166	7611664189173
Description	switchButler WiFi & Bluetooth 1/3/1 channels, GSM/UMTS/LTE	switchButler WiFi & Bluetooth 1/3/1 channels, GSM/UMTS/LTE with power supply unit	switchButler WiFi & Bluetooth 1/3/1 channels, GSM/UMTS/LTE with power supply unit, temperature and humidity sensor
Picture			
Scope of supply	<ul style="list-style-type: none"> <li>• SMSB131BW remote control unit</li> <li>• M16 cable gland</li> <li>• M16 grommet</li> <li>• Quick instructions</li> <li>• Antenna (integrated)</li> </ul>	<ul style="list-style-type: none"> <li>• SMSB131BW remote control unit</li> <li>• M16 cable gland</li> <li>• M16 grommet</li> <li>• Quick instructions</li> <li>• Antenna (integrated)</li> <li>• Power supply unit</li> </ul>	<ul style="list-style-type: none"> <li>• SMSB131BW remote control unit</li> <li>• M16 cable gland</li> <li>• M16 grommet</li> <li>• Quick instructions</li> <li>• Antenna (integrated)</li> <li>• Power supply unit</li> <li>• Bluetooth temperature and humidity sensor</li> </ul>

## 12 Accessories

	SMSBNP12 E-No. 960 900 539		SMSBZBW E-No. 539 149 000
	BTH1 E-No. 536 100 500		SMSBZMB E-No. 539 149 030
	SMSBV5-01 E-No. 539 190 050		SMSBZDIN E-No. 539 149 010
	SMSBV10-01 E-No. 539 190 100		SMSBAI-015M E-No. 539 191 010
	SMSB-PT100 E-No. 539 199 010		SMSBAI-3MLTE E-No. 539 191 040

Article No.	E-No.	Description
<b>Power supply units</b>		
SMSBNP12	960 900 539	Plug-in power supply 230VAC /12VDC / 1 A
SMSBN12UP	960 900 439	Flush-mounted power supply unit 230VAC /12VDC / 500 mA
SMSBNE12-01	960 900 339	Power supply unit DIN rail mounting 230VAC /12VDC / 1 A
<b>Sensors</b>		
BTH1	536 100 500	Bluetooth temperature and humidity sensor
SMSB-PT100	539 199 010	Temperature sensor PT100, PVC cable, 1.5 m, grey
<b>Extensions</b>		
SMSBV5-01	539 190 050	SMA antenna extension with 5m, cable M/F
SMSBV10-01	539 190 100	SMA antenna extension with 10m, cable M/F
<b>Antennas</b>		
SMSBAI-3M-LTE	539 191 040	Multiband antenna with wall mounting bracket, 3 m cable SMA-M plug LTE, GSM, UMTS
SMSBAI-015M	539 191 010	Cable adapter IPX-SMA 150 mm, black
<b>Assembly accessories</b>		
SMSBZBW	539 149 000	M4 stainless steel mounting bracket, 2 pieces
SMSBZMB	539 149 030	Stainless steel rod fastening set, clamping range 40-320 mm, incl. screws and washers
SMSBZDIN	539 149 010	DIN rail adapter, plastic, black

**13 Dimensions**

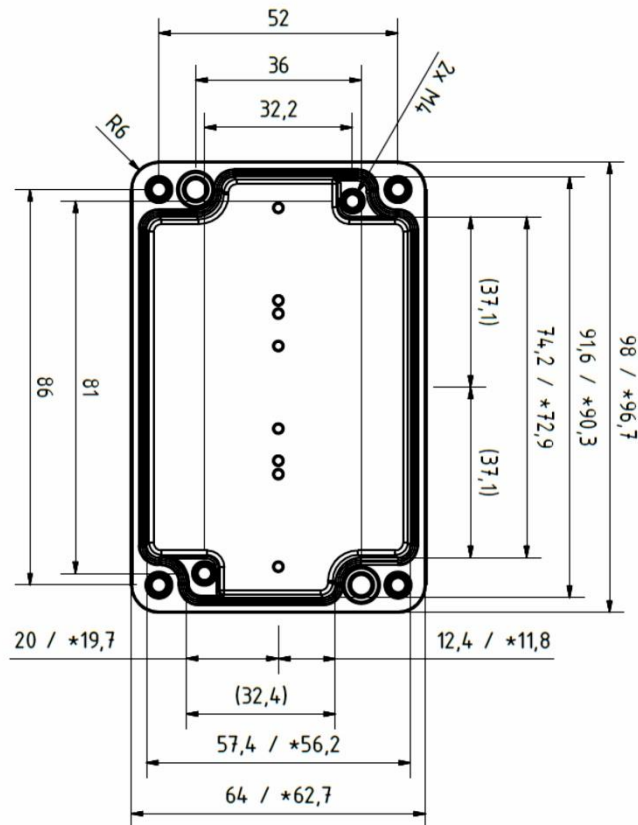
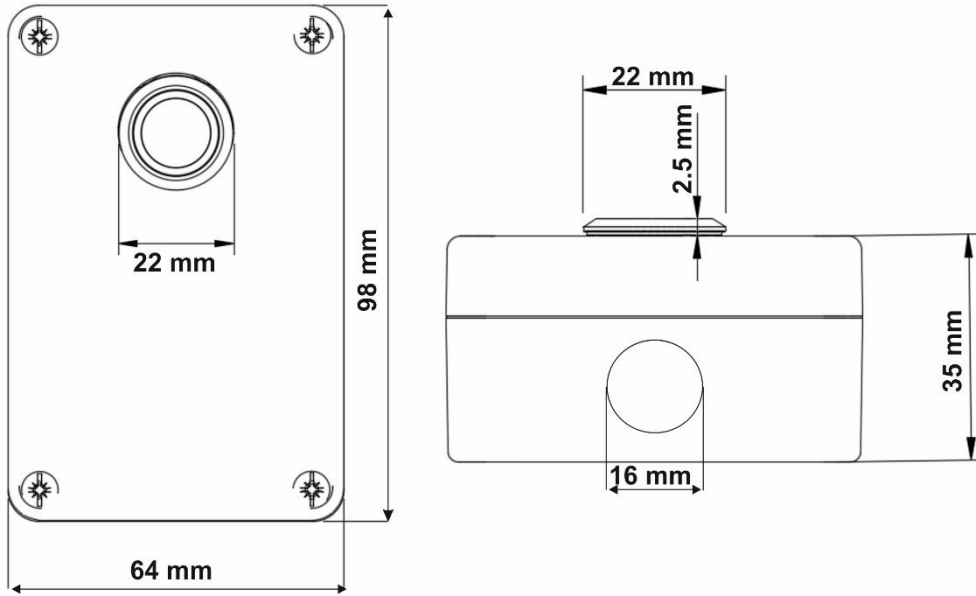



## 14 Interfaces

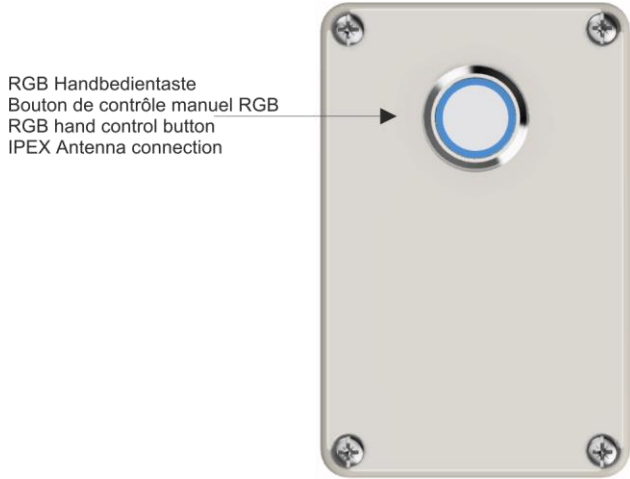

RGB Handbedientaste  
Bouton de contrôle manuel RGB  
RGB hand control button  
IPEX Antenna connection

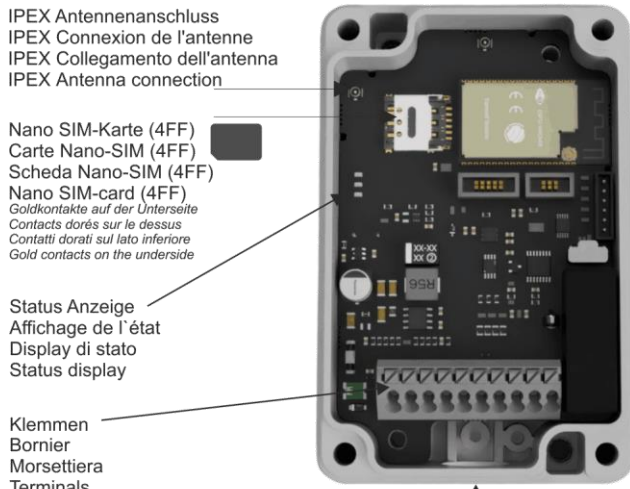

IPEX Antennenanschluss  
IPEX Connexion de l'antenne  
IPEX Collegamento dell'antenna  
IPEX Antenna connection

Nano SIM-Karte (4FF)  
Carte Nano-SIM (4FF)  
Scheda Nano-SIM (4FF)  
Nano SIM-card (4FF)  
Goldkontakte auf der Unterseite  
Contacts dorés sur le dessous  
Contatti dorati sul lato inferiore  
Gold contacts on the underside

Status Anzeige  
Affichage de l'état  
Display di stato  
Status display

Klemmen  
Bornier  
Morsettiara  
Terminals

Gewinde M16 für Kabelverschraubung oder Würgenippel  
Filetage M16 pour presse-étoupe ou passe-câble  
Filettatura M16 per pressacavo o canalina  
Thread M16 for cable gland or choke nipple

### 1. Manual control button

For the manual control of the relay, reset to the factory setting and status display.

Function	Operation
Switching the relay on/off	Press manual control button for 2 s
Reset	Disconnect power supply
Factory setting	Press manual control button for 20 s, flashing red
Status	Meaning
Red	Relay off
Green	Relay on

### 2. IPEX antenna connection

Connection for antenna extension in accordance with accessories

### 3. Sim card holder

Nano SIM card (4FF) insertion as specified in Chapter 9.6

### 4. Status display

Indicates the system status

System	LED	Status
Power	On	Ok
	Off	Error
Network	On	Search network
	200 ms On, 200 ms Off	Data transmitted, 4G registered
	200 ms On, 200 ms Off	2G/3G registered
	Off	Switched off, standby mode
CPU	On	Ok
	Off	Error

### 5. Clamps

8 x 14 to 20 (AWG) 2.08 to 0.518 (mm<sup>2</sup>)

### 6. M16 thread

:

## 15 Installation diagram

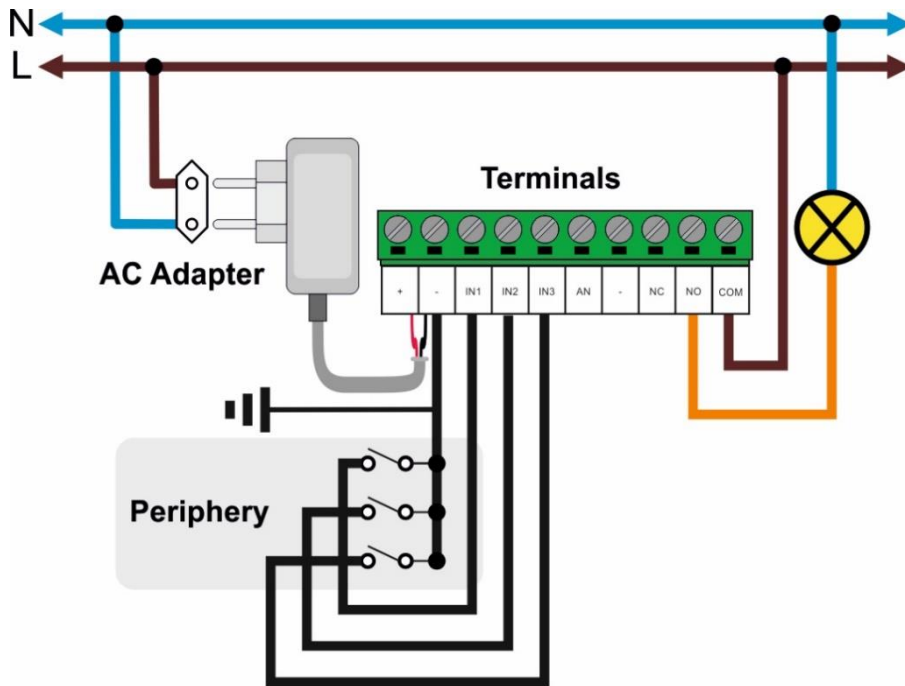

Mechanical contact

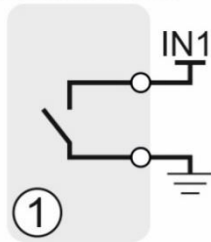

Zero-potential, mechanical contact, e.g. pressure switch, temperature switch, limit switch, pushbutton, relay output

Photocoupler-isolated open-collector output

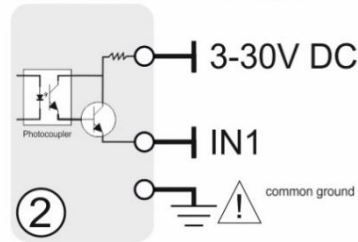

Voltage output contact, e.g. PLC.

### 15.1 Analog input

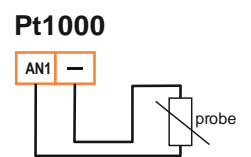
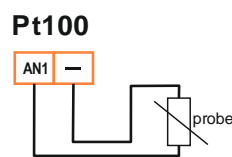
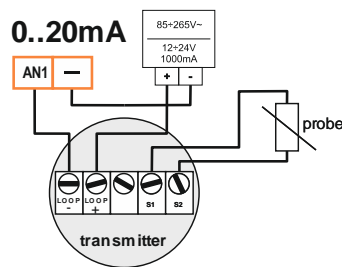
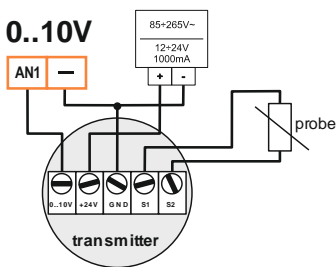

### 15.2 Digital inputs

The digital inputs serve to monitor systems and devices. Via a potential-free contact in the periphery, which can be programmed as NO contact or NC contact, the users defined can be alerted via SMS or email. Wire the inputs as shown in the installation diagram.

### 15.3 Relay output



The installation instructions must be strictly observed with regard to the nameplate data (see corresponding chapter).

## 16 Programming

### 16.1 Getting started

In general, the SMSB131BW is ready for operation without having to be programmed. Basic commands such as switching on and off can also be carried out without prior programming. However, if you wish to program these functions, please download the App for your Android or iOS smartphone. Please connect your SMSB131BW to the power supply unit/the power supply as specified in the instructions.



### 16.2 Registration

Register in the App once.

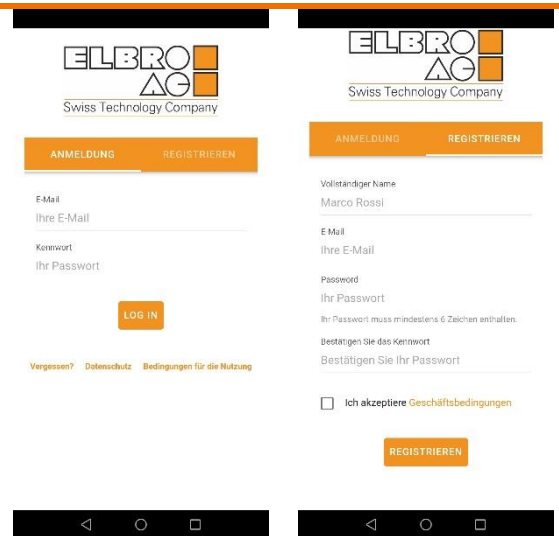

### 16.3 Settings

In the settings you select the language for the App; you can also delete your account here.

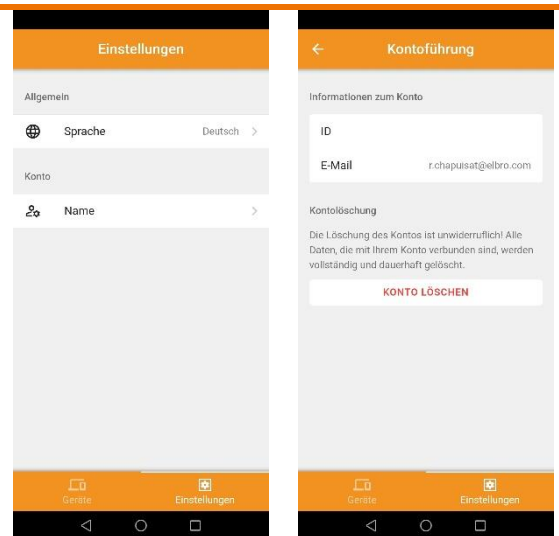

## 16.4 Coupling the device via bluetooth

After you have registered and logged in successfully, you can view the devices available via bluetooth in your proximity. To make the SMSB131BW visible and allow for successful coupling, it has to be connected to the power supply as specified in the instructions. Please select the device which you wish to couple. The RSSI value stands for "Received Signal Strength Indicator" (indicator for the received signal strength) - the lower the value, the better the connection.

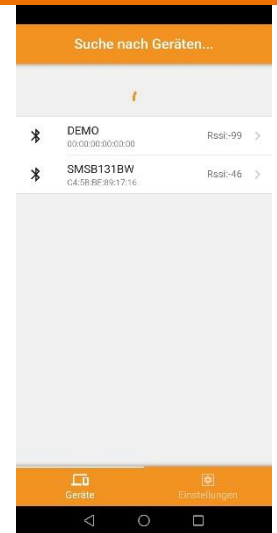

## 16.5 System status

### 16.5.1 I/O- status

Overall view of the status indication for the inputs and outputs of the SMSB131BW. The temperature and humidity indications refer to the internally mounted sensor. The values do not refer to an external sensor.

### 16.5.2 LTE module status

Details regarding the network of the mobile provider and the telephone status. Here, important information such as the signal strength, provider, remaining credit and the technology used is displayed.

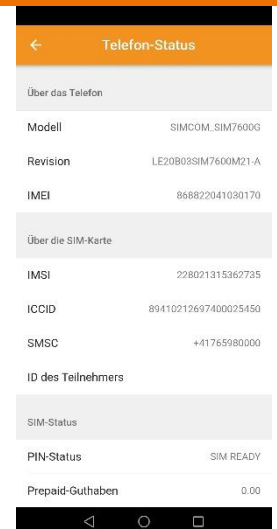
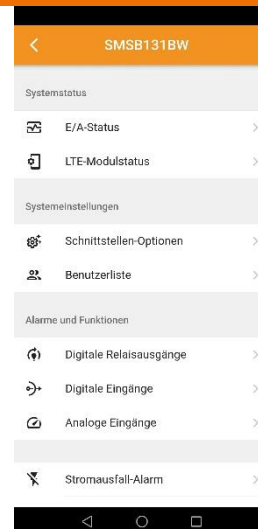

## 16.6 System settings

### 16.6.1 Interface options

Here you can carry out relevant safety and comfort settings. Name your device individually and define an alphanumerical password for incoming text messages.

Define the colour and intensity of the pushbutton on the front according to your wishes.

If you use a prepaid SIM, you can activate the credit query function to continuously monitor your current costs.

#### Query code

Swisscom	*130#
Sunrise	*121#
Salt	Service is not supported

### 16.6.2 User

This list contains the personal data of the users that are authorised to receive alarm messages. Every user's profile can be created individually and changed any time. In order to edit or delete an existing profile, just swipe to the right.

Functions	Notification/connection
Relay	<ul style="list-style-type: none"> <li>In/off</li> <li>Pulse switching</li> <li>Automatic switching (logic)</li> <li>At an incoming call</li> </ul>
Digital input 1	<ul style="list-style-type: none"> <li>Potential-free contact as NO or NC contact</li> <li>Voltage-dependent contact</li> </ul>
Digital input 2	<ul style="list-style-type: none"> <li>Potential-free contact as NO or NC contact</li> <li>Voltage-dependent contact</li> </ul>
Digital input 3	<ul style="list-style-type: none"> <li>Potential-free contact as NO or NC contact</li> <li>Voltage-dependent contact</li> </ul>
Analog input	<ul style="list-style-type: none"> <li>0-10 V</li> <li>0-20 mA; 4-20 mA,</li> <li>PT100</li> <li>PT1000</li> </ul>
Power failure message	<ul style="list-style-type: none"> <li>In the event of a power at the voltage supply</li> <li>In the case of voltage events</li> </ul>
Periodic status message	<ul style="list-style-type: none"> <li>Notification on the status at regular time intervals</li> </ul>
Wireless sensors	<ul style="list-style-type: none"> <li>In the case of a temperature or humidity alarm</li> </ul>

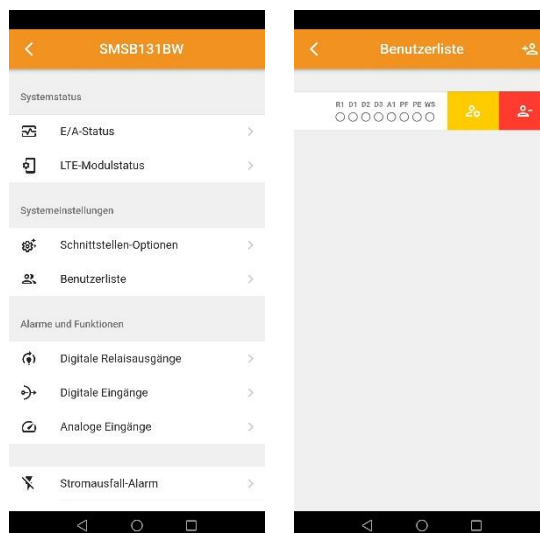
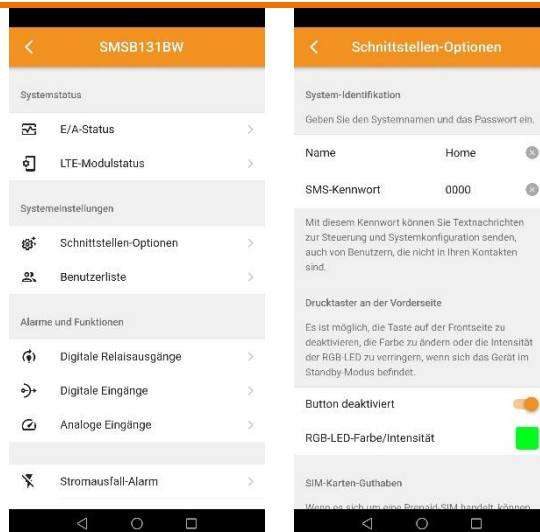

## 16.7 Alarms and functions

### 16.7.1 Relay

Configure your relay here. Here you can choose between ON/OFF, pulse switching, automatic switching or switching at an incoming call. In order to be able to use this function, please activate the relay permission for the desired user.

### 16.7.2 Digital inputs

The digital inputs can be programmed individually and independently of each other. Select the type of contact and define the alarm text and a possible delay for an alarm event.

- Potential-free contact as NO or NC contact
- Voltage-dependent contact

### 16.7.3 Analog input

The SMSB131BW is provided with an analog input that can be configured with probes 0-10 V, 0-20 mA, 4-20 mA, PT100 or PT1000.

### 16.7.4 Power failure message

#### Input voltage

This function allows for sending a notification to users defined in advance when a power failure occurs and/or ends. A potential power failure is bridged in the device by means of a capacitor.

#### Voltage event

Additionally, the voltage supply can be monitored. This function is useful in particular for systems separated from the network such as self-sufficient traffic surveillance systems. In this way, for example the 12 V battery supplied by the photovoltaic system can be monitored.

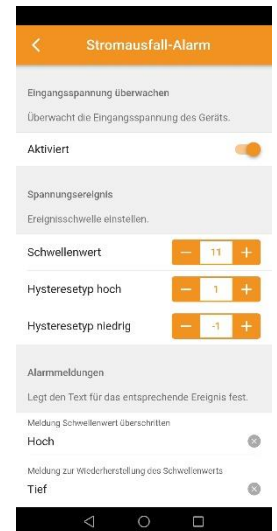
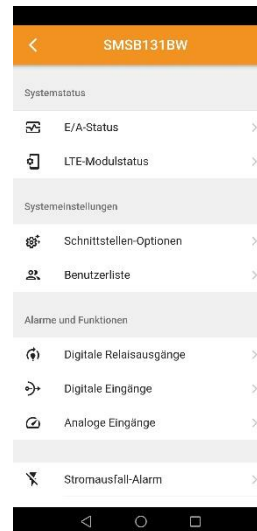
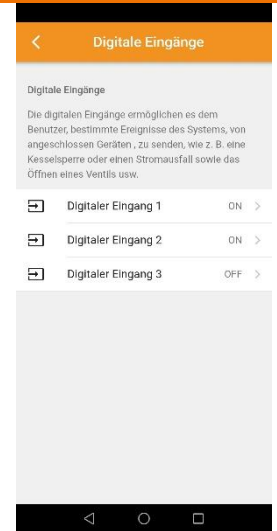
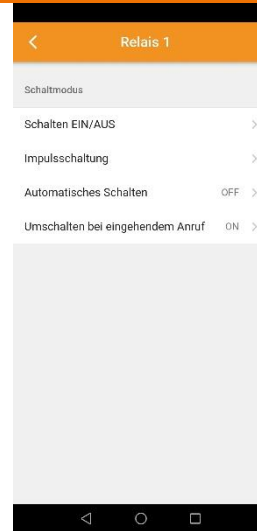

## 16.8 Periodic status message

You can use this function to have a message sent to activated users at regular intervals (daily, weekly or monthly). This mode is helpful to permanently monitor an installation or to avoid the expiry of SIM cards when they are not used for a longer time.

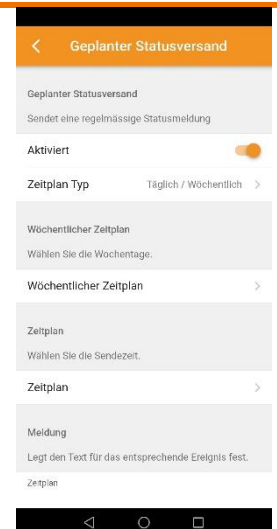
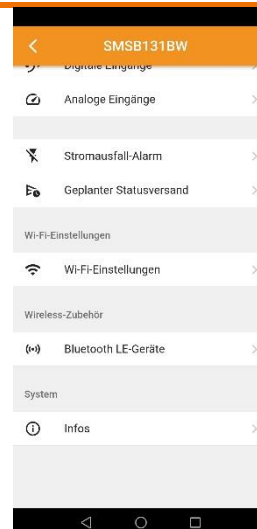

### 16.9 Wi-Fi settings

Activate Wi-Fi and enter the SSID and the password for the network. The password field is mandatory to fill out.

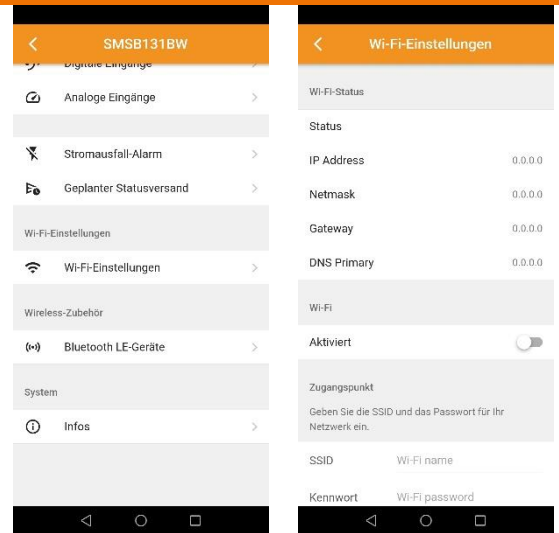

### 16.10 Wireless accessories

Connection of wireless sensors via bluetooth. Take the device near the telephone and press the “Add” button at the top right. After successful coupling, you can personalise the wireless sensors. Define your own temperature and humidity alarm.

**i** The sensor is mandatory for the thermostat function.

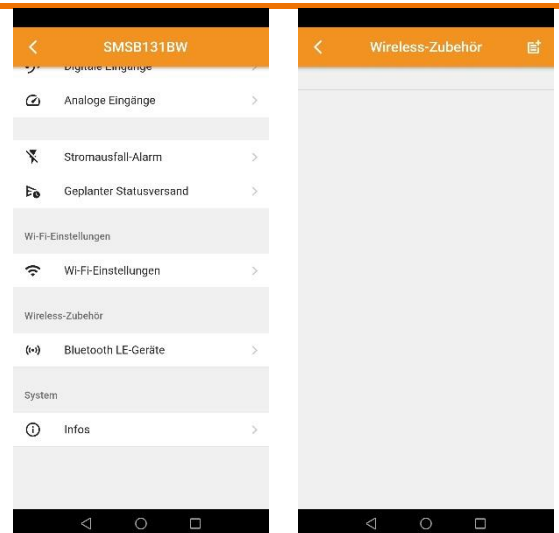

### 16.11 Save

At the end of each change, the changed parameters must be sent from the APP to the device. To do this, please click on the moving symbol at the top right until it disappears. Confirm with Ok.

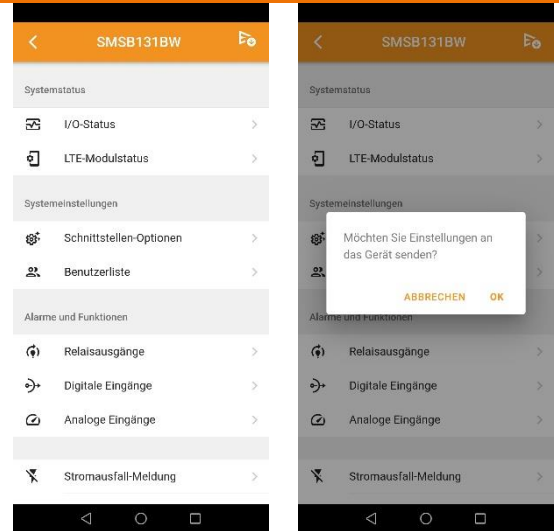

### 16.12 System

#### 16.12.1 System information

Indication of the relevant system information.

- Model
- Manufacturer
- Serial number
- Hardware revision
- Firmware revision
- Web browser revision

#### 16.12.2 System update

To carry out the update, the device first must be connected to a Wi-Fi network that is connected to the Internet. You can also use a hotspot on a mobile phone. Then you select "Check update", so your device will check automatically whether a new firmware is available.

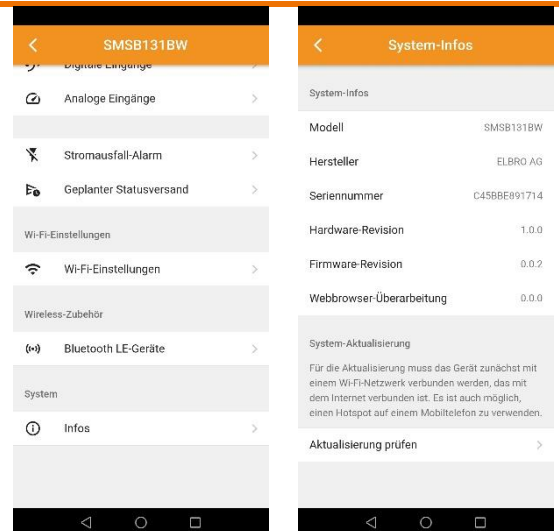



## 17 SMS commands

The SMSB131BW is provided with various configuration and control commands that can be sent via SMS. The command message is protected by a password. The format of the command message is as follows:

**[PASSWORD]#[COMMAND] Example: 0000#1**

 The default password for the command message is → 0000

The password always has a length of 4 characters long and hashtag (#) is a mandatory separator. You can replace it with the character dot (.)

### 17.1.1 Switching relays on/off

Command	Description	Example
[PW]#0	Switches off the relay	0000#0
[PW]#1	Switches on the relay	0000#1

### 17.1.2 Status request

Command	Description	Example
[PW]#?	Status request	0000#?

### 17.1.3 Thermostat function

Command	Description	Example
[PW]#A[1-69]	Activates temperature-dependent relay output (thermostat function)	0000#A21 0000#A8

 Registered users in the user list, can also send commands without password → #0

## 18 Manual switch

### 18.1.1 Switching the relay in manual mode

To switch the relay manually, press the button for 2 seconds and let go of it again. The button reports back the relay status optically to you, see "Interfaces" chapter.

### 18.1.2 Manual restart

To restart the SMSB131BW without losing the settings, you have to disconnect the power supply. The term "disconnect" refers to the all-pole switch-off.

### 18.1.3 Manual restart to default setting

To delete and reset all settings, keep the button pressed for at least 20 seconds and let go of it again. The button reports back the reset optically to you, see "Interfaces" chapter.

## 19 Technical data

<b>Radio</b>	4G LTE Cat 1, GNSS receiver ready (on request) Frequencies: <ul style="list-style-type: none"> <li>• LTE-TDD B34/B38/B39/B40/B41</li> <li>• LTE-FDD</li> <li>• B1/B2/B3/B4/B5/B7/B8/B12/B13/</li> <li>• B18/B19/B20/B25/B26/ B28/B66</li> <li>• UMTS/HSPA+</li> <li>• B1/B2/B4/B5/B6/B8/B19</li> <li>• GSM/GPRS/EDGE</li> <li>• 850/900/1800/1900MHz</li> </ul>
<b>Wi-Fi range</b>	802.11 b/g/n (802.11n up to 150 Mbps) Frequencies: 2.4 GHz ~ 2.5 GHz
<b>Bluetooth</b>	Bluetooth v4.2 BR/EDR and BLE
<b>SIM card slot</b>	Nano SIM (4FF) foldable SIM card connection (SIM card not included in the scope of supply)
<b>Memory slot</b>	Micro SD card (not included in the scope of supply) for GNSS recordings or logging (optional).
<b>LTE antenna</b>	Integrated, optionally an external antenna with IPX connection can be installed.
<b>Clamps</b>	8 x 14 to 20 (AWG) 2.08 to 0.518 (mm <sup>2</sup> )
<b>Power supply</b>	Supply voltage: 12÷24V DC; extended 9÷30V DC Current: I <sub>MAX</sub> = 1000 mA Power supply with reverse polarity protection and short-circuit-proof
<b>Outputs</b>	1 relay form C (SPDT-NO, NC) ⚠ ⚠ Rated load: <ul style="list-style-type: none"> <li>• 10 A at 250 VAC, (NO) ohmic load</li> <li>• 8 A at 250 VAC, ohmic load</li> <li>• 5 A at 30 VDC, ohmic load</li> </ul>
<b>Inputs</b>	3 programmable digital inputs (potential-free/voltage-dependent) 1 analog input: 0-10 V; 0-20 mA; 4-20 mA; PT100; PT1000
<b>General characteristics</b>	Information regarding the colour <ul style="list-style-type: none"> <li>• Colour description light grey</li> <li>• RAL code 7035</li> </ul> Information regarding the material <ul style="list-style-type: none"> <li>• Housing material polycarbonate</li> <li>• Screw material stainless steel V2 A</li> <li>• Silicone-free</li> <li>• Halogen-free</li> <li>• Material UL listed</li> <li>• UV resistant</li> </ul> Temperature resistance and areas of application <ul style="list-style-type: none"> <li>• Continuous operating temperature max. 80 °C</li> <li>• Continuous operating temperature min. -40 °C</li> <li>• Suitable for inside/outside use</li> </ul> Weight <ul style="list-style-type: none"> <li>• 180 g</li> </ul> Dimension <ul style="list-style-type: none"> <li>• 98x64x35 mm</li> </ul> Customs tariff number <ul style="list-style-type: none"> <li>• 85437000</li> </ul>

## Country of origin

- CH

## Technical characteristics of the housing

- Degree of protection
  - IP67 with cable gland
  - IP55 with grommet
- Standard of protection class DIN EN 60529
- Impact strength IK08
- Flame retardancy V2
- UL approval UL 94
- Protection class II
- Seal foamed, seamless
- Captive cover screws
- Assembly tool PZ2
- Tightening torque cover screws max. 2.00 Nm
- Tightening torque cover screws min. 1.00 Nm

## Consumption (typical values)

- Voltage supply 12V DC
- Standby
- Sending SMS
- Receiving SMS
- Switching relay
- GPRS/UMTS

**Declaration of conformity**

ELBRO AG hereby declares that the product SMSB131BW complies with the fundamental requirements and other relevant provisions of the RED Directive